

CB central battery version

CB version is being monitored directly by a central battery system controller, in a way depending on such system's possibilities and settings.

FAULTY OPERATION AND ITS POSSIBLE DIAGNOSIS

LED indicator does not light up

AC power failure.

LED indicator is red

Possible damage of one of a luminaire's elements: a charging circuit, a light source supply circuit, a light source itself, a battery or an autonomy operation in an emergency mode is too short. It is recommended to repeat the test and - in a case of confirmation of bad results to call a service team. For more information, please, refer to the "TESTING" section.

LED indicator blinks red

The luminaire performs testing. Please, refer to the "TESTING" section.

The luminaire does not operate in emergency mode the required time for a selected model

It is possible that the battery requires a full charge cycle (24h). If after 24 hours of charging the luminaire still does not keep a predefined autonomy, it is possible that the battery is run-down or damaged, e.g. due to possible incorrect formatting and needs to be replaced.

RECOMMENDED PERIODICAL MAINTENANCE

The luminaire should be tested on regular basis in accordance with valid laws and regulations. The results of the tests should be recorded and stored for the use of a fire safety inspector.

One time daily

It is suggested to check visually if the LED indicator in the luminaire lights up in green.

One time each month

It is necessary to perform a function test by disconnecting the AC power supply and checking whether the luminaire is operating in emergency mode - the green LED indicator should turn off, and LED light source light up. For an MT version the test is being performed manually, for AT and CT versions is being performed automatically, according to programmed cycles.

One time each year

In order to make an autonomy test, disconnect the AC power supply and test if the luminaire operates in emergency mode for a specified time. If the autonomy time of emergency operation is not sufficient, the battery needs to be fully recharged and the test is to be carried out again. If the result of the test continues to be negative, the battery needs to be replaced. For an MT version the test is being performed manually, for AT and CT versions is being performed automatically, according to programmed cycles.

CAUTION!

All damage that might occur as an effect of the device being used not in accordance to this instruction will result in loss of guarantee.

Used or damaged lamps including batteries, are subject to be recycled. They should be delivered to the point of collection of electrical and battery waste or to the manufacturer.



The light source contained in this luminaire shall only be replaced by the manufacturer or his service agent or a similar qualified person.

Handling of obsolete equipment

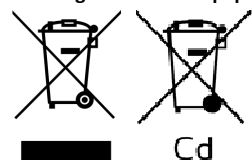

Pursuant to the Act of 29 July 2005 on waste electrical and electronic equipment and the Act of 24 April 2009 on batteries and accumulators, the presented device, after use, due to hazardous substances contained in it, is subject to collection of waste electrical and electronic equipment. Detailed information on WEEE collection can be obtained from municipal authorities.

intelight
Intelight Sp. z o.o.
8, Rydygiera str.
01 -793 Warsaw, Poland

intelight

WARS LED PANEL EMERGENCY LUMINAIRE

Installation and maintenance instructions



WARS LED PANEL

Version:

WARS LED PANEL

TECHNICAL SPECIFICATIONS:	
Light source (user non-replaceable):	White LED
Operating modes:	SA (M) – mains and emergency operation
Test versions*:	MT – manual test, AT – auto test, CT – central test or CB (central battery) version
Emergency autonomy*:	1h, 2h, 3h or 8h
Output (emergency) power*:	2W, 3W, 6W, 9W or 12W
Battery (replaceable)*:	NiCd or NiMH: 3.6V 1500mAh ÷ 5000mAh or LiFePO4: 12.8V 600mAh ÷ 10000mAh
Battery charging duration:	24h
Power supply*:	MT, AT and CT: 220-240V AC 50Hz or CB (central battery): 230V AC / 220V DC
Max. power (consumption)*:	20W ÷ 65W
Module*:	Primus LED or Primus LED HP
Luminous flux*:	min. 230lm ÷ min. 1575lm
Enclosure IP rating:	IP65
Ambient temperature:	10°C ÷ 30°C (standard versions) or -25°C ÷ 30°C (LT versions)

*- depending on model



INTRODUCTION

1. The lamp should be installed when power supply is off. Safety rules, construction and electrical installation standards should be followed all the time.
2. The luminaire should not be powered with circuits connected to inductive power-receiving devices at the same time. This type of solution may cause damage to the electronic module of the luminaire.
3. The luminaire should be used indoors.

INSTALLATION

1. Before installation one has to make sure that the luminaire will be connected to 220-240VAC power supply by the use of minimum a 1,5mm² wire.
2. The fixture should be mounted by means of installation brackets (attached). One need to prepare holes and plugs for fixing of installation brackets. Each bracket must be fixed by means of 2 screws (attached). Distances between ceiling holes for each bracket should equal to 26mm for 1x fixture widths and 50mm for 2x fixture widths. Distances between two brackets for 60, 120 and 150 fixture lengths should equal to 400mm, 898mm and 1002mm, respectively. See the drawings – part "I" | "II".

- After the brackets are mounted, one need to install the fixture by clicking it into the prepared brackets.
- In order to connect a supply wire, one need first to remove a luminaire's diffuser (cover) by unclicking all the fixing clips which fix the cover to the base. Then one need to open a gear tray fixings (squeezing to the centre two bifurcated fixings for 1x fixtures or turning wing fixings for 2x fixtures) and to put it out (the gear tray should hang on slings which keep it fixed to the base's bottom). See the drawings – part "III".
- Connect all the wires of a prepared power cable to the appropriate terminal block entries. See the drawings – part "IV".
The description of luminaire's terminals:
L - phase wire - brown or black insulation colour; power source for battery charging, presence signalled by signal LED lighting up in green;
L1 – a terminal to be optionally used for a wall switch connection, enabling to switch a luminaire off during M mode operation, if no switch is used the terminal L1 should be connected to a phase wire in parallel with the L terminal;
N - neutral wire - blue insulation colour;
PE – protective earth wire – yellow and green insulation colour.
- Luminaire designed for EMERGENCY operation (A, NM).** The luminaire should be constantly supplied by power - voltage drop on L will result in emergency mode activation.
- Before connecting the luminaire to the mains network, insert the white battery plug into the socket on the PCB.
- Please remember to indicate the date of installation on the label attached to the battery pack.
- In order to finish the installation, one need to click the gear plate into the gear tray fixings then to put the cover and to carefully and precisely latch all the fixings (which fix the cover to the base). One need to pay attention to a proper closing of the cover and screwing a cable gland in – the declared IP level depend on these details. See the drawings – part "V".
- For quick operation testing – switch on the AC power supply. The green LED indicator should light up, signalling the mains connection and battery charging. After battery is charged, the LED indicator should still light up in green, what means readiness for emergency operation. By pressing the test button, one can check if the luminaire enters the emergency operation when the power supply is off. The way how to press the test button and how to read the luminaire's behaviour depends on its version. You can find detailed information in the "TESTING" section.
- First-time charge of the luminaire battery pack should be carried out continuously for 48 hours. This will allow appropriate formatting of the battery pack. During the first-time charge, no testing should be carried out and power supply should not be disconnected for any other purpose. Power supply should be disconnected after 48 hours for the first time. The luminaire should complete a full emergency operation cycle, after which it should be connected to power supply for another 36 hours. This sequence shall complete the formatting cycle.

OPERATION

Mains and emergency operation mode

In this mode (SA, M) the luminaire lights up when powered by AC supply voltage. Correct operation of the device is also confirmed by LED indicator lighting up in green. The battery is being continuously trickle charged for the purpose of possible emergency operation. When AC power supply is off (no voltage on L), the luminaire automatically starts operating in emergency mode and the source of light is activated for the period specific for a particular model. During emergency operation, the LED indicator is off.

Information on lamp operation

The luminaire operates correctly and charging circuit works if the LED indicator lights up in green. If the indicator does not light up, the lamp is not operating with AC power supply on or any luminaire's element (e.g. the battery) has been damaged. See more info about signaling in "TESTING" section.

Battery pack

The luminaire is equipped with a rechargeable nickel-cadmium NiCd, nickel-metal-hydride NiMH or lithium-iron-phosphate LiFePO4 battery pack. Please remember to carry out the correct first-time charge cycle (see "INSTALLATION", p.11). After such a formatting cycle it achieves its capacity and is prepared to perform a possible full time emergency operation. It is suggested to discharge and then to re-charge the battery every three months, even if it hasn't been used, in order to extend its performance. It is recommended to replace the battery once every four years of operation or in a case of poor test results. Obsolete batteries, similarly to packaging, fluorescent lamps or electronics, are recyclable products that should be disposed to a recyclable waste collection point.

TESTING

WARS LED PANEL luminaire can be delivered with a manual MT, auto AT or central CT test versions. It is equipped with a test button that can be optionally used for manual tests' initiations. It enables to check the readiness for emergency operation at any time, apart from planned tests. NOTE! – if such an optional test is finished less than 24h before any planned test, the planned test will be delayed in order to achieve full 24h battery charging time. The delay will be applied also in a case of mains failure and its restoration at the moment that is closer than 24h before such a planned test.

AT auto test function

If a luminaire version has an auto test functionality, the TEST button is being used to initiate and break either function or autonomy tests. When the luminaire is connected to mains network and there is no voltage drop, pressing and holding the test button, depending on time of pressing, will result in activation of any of the two. Pressing the button for more than 2s and not longer than 5s (2s<t<5s) initiate the function test, for more than 10s and not longer than 15s (10s<t<15s) – initiate the autonomy test. For a convenient counting of seconds – when a test button is pressed and hold – after every second the luminaire confirms the passing

time by a quick flash of a red indication LED. When the luminaire is during any (manually initiated) test procedure, pressing the button for a time longer than 10s (t>10s) – breaks any currently running test.

In a standard luminaire's operation, both functional and autonomy tests are being initialised automatically, function test every 28 days and autonomy test every 336 days. There is no possibility to break any automatically planned test. There is also no possibility to erase any test results, this means that any signalled failures will be cancelled only after making the luminaire repaired.

IMPORTANT – in a case of a power failure happening while a test is being performed, the luminaire breaks it, then starts emergency operation. After the emergency operation is finished and after a power return the luminaire won't signal any test's results (only green LED will be on, as in a basic state). The interrupted planned test (if the power failure was shorter than 7 days) shall be repeated after min. 24h after the power return. The test initiated manually won't be repeated.

All the possible luminaire working states and LED indications are gathered in the table below.

LUMINAIRE WORKING STATE OR ACTION	GREEN LED INDICATION	RED LED INDICATION	COMMENTS
BASIC STATES			
MAINS SUPPLY ON, BATTERY BEING CHARGED	ON	OFF	
MAINS SUPPLY FAILURE, EMERGENCY OPERATION	OFF	OFF	
FUNCTIONAL TEST STATES			
FUNCTIONAL TEST - PART 1 (LIGHT SOURCE AND ELECTRONICS)	OFF	FLASHING (1/T2)	DURATION: 60s
FUNCTIONAL TEST - PART 2 (CHARGING CIRCUIT)	ON	FLASHING (2/T)	DURATION: 10s
CHARGING, ELECTRONIC CIRCUIT, LIGHT SOURCE OR BATTERY FAILURE	ON	ON	
LUMINAIRE (ELECTRONICS, BATTERY, LIGHT SOURCE) – OK	ON	OFF	
AUTONOMY TEST STATES			
AUTONOMY TEST - PART 1 (LIGHT, ELECTRONICS, AUTONOMY)	OFF	FLASHING (2/T2)	DURATION: 1h, 2h, 3h, 8h(*)
AUTONOMY TEST - PART 2 (CHARGING CIRCUIT)	ON	FLASHING (2/T)	DURATION: 10s
CHARGING, ELECTRONICS, LIGHT SOURCE, BATTERY OR AUTONOMY FAILURE	ON	ON	
LUMINAIRE (ELECTRONICS, BATTERY, AUTONOMY, LIGHT SOURCE) – OK	ON	OFF	
MANUAL TEST BUTTON FUNCTIONS			
INITIATION OF A FUNCTIONAL TEST – PRESSING A BUTTON FOR A 2s<t<5s	ON	FLASHING (1/T)	FLASHING ENABLES TIME (t) COUNTING
INITIATION OF AN AUTONOMY TEST – PRESSING A BUTTON FOR A 10s<t<15s	ON	FLASHING (1/T)	
BREAKING OF ANY TEST (**) – PRESSING A BUTTON FOR A t>10s	FLASHING (5/T)	FLASHING (***)	

T – 1s period; T2 – 10s period; t – time of pressing the test button

FLASHING: (1/T) / (2/T) / (5/T) – 1 flash / 2 flashes / 5 flashes every 1s period

FLASHING: (1/T2) / (2/T2) – 1 flash / 2 flashes every 10s period

(*): test duration is same as an autonomy time declared for a given luminaire

(**): automatic normative tests cannot be interrupted, it concerns solely manual tests

(***): signaling depends on a test being executed at the moment, as in a given test

CT central test version

This version in a basic make is designed for co-operation with a WELLS wireless central monitoring system. All control possibilities are described in a separate instruction manual dedicated for WELLS system. Signaling ways of all luminaire's states and tests' schedules and results are identical to those described for AT version. Additional states are described below. An "UNBOUND" signal means that a luminaire is not (temporarily or permanently) in a communication contact with a control unit:

LUMINAIRE WORKING STATE OR ACTION	GREEN LED INDICATION	RED LED INDICATION	COMMENTS
WELLS COMMUNICATION STATES			
„UNBOUND“ SIGNAL, 24h AFTER LOSS OF COMMUNIC. WITH A CENTRAL UNIT	FLASHING (6/T2)	FLASHING (6/T2)	SIMULTANEOUS

FLASHING (6/T2) – 6 quick consecutive simultaneous pairs of green LED and red LED flashes, repeated in a 10s period, the sequences interrupt signalling of a basic luminaire's state (according to the table described for AT)

IMPORTANT – for a luminaire not connected with a central unit (wireless network) it means only no connection between the luminaire and the central unit. The luminaire can be still working correctly, performing planned tests and signalling their results on signal LEDs, assuring safety of a building, but tests' results are not being transferred to a central unit.

MT manual test version

This luminaire's version is equipped in one green signal LED. It signals connection to a mains network. For a luminaire installed properly it means that a battery is being continuously charged / trickle charged. Mains failure makes the signal LED going off and powering the luminaire from its battery pack. A situation when – despite connected mains network – signal LED is off, may mean a failure or a damage of either an electronic circuit, a battery or a light source.

When the emergency luminaire is connected to mains and there is no voltage drop, pressing and holding TEST button will result in activation of the "voltage drop" mode, the signal LED will go off and the luminaire should light up. When the button is released - the luminaire will switch back into its standard operation mode.

The above action means that in a case of emergency mode version the luminaire will go from unlit to illuminated. In a case of mains and emergency mode the luminaire will change a power source from mains to a battery supply, the switch-over moment should be visible as a quick blink – during a very short while the light source will be off.

I. CLICKING-IN CLOSING CLIPS

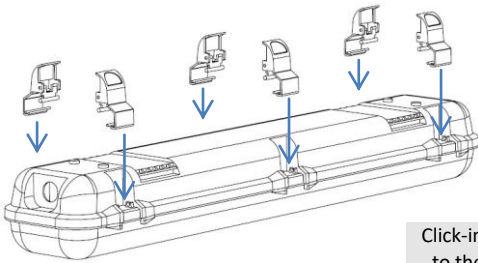

Click-in all closing clips to the base in a way shown on the right

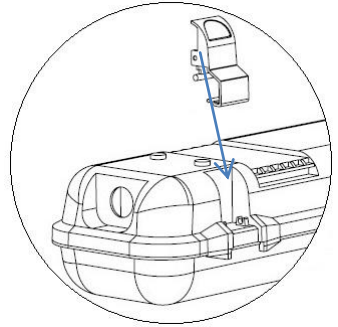

II. FIXING TO THE CEILING

Fix installation brackets (2 pcs) to the ceiling using attached plugs for concrete wall and screws (both 4 pcs, 2 pcs per bracket), spacing A depends on a fitting's length

On-ceiling way

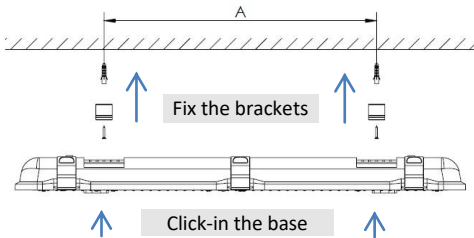

The base fixed to a ceiling

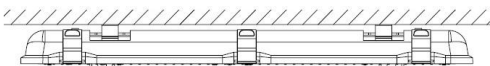

Suspended way
(needs an accessory - suspension mounting kit)

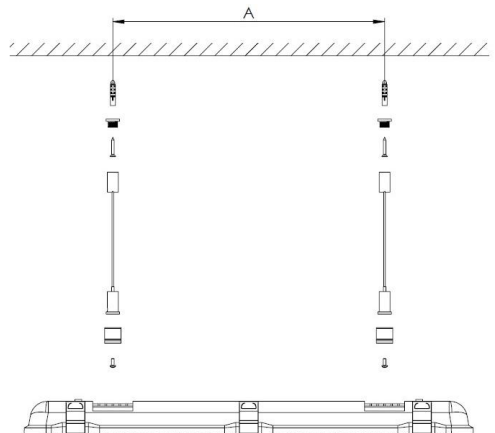

INSTALLATION DRAWINGS

III. OPENING THE MOUNTING PLATE

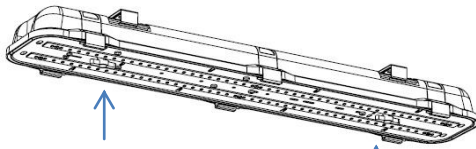

Open the mounting plate by opening 2 fixings by...

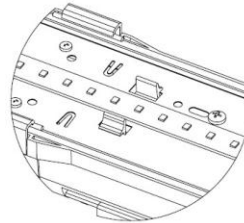

...squeezing the bifurcated fittings for 1x version fittings

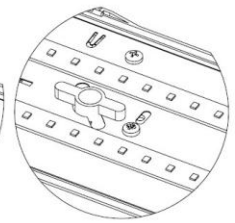

...turning the wing fixings by 90° for 2x version fittings

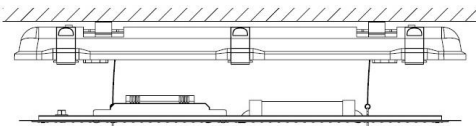

Let the mounting plate hang loose on 2 safety slings (first make sure they are attached both to the base and the plate)

IV. POWER CABLE WIRING

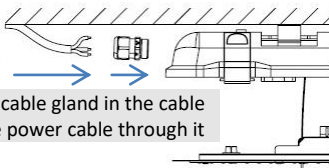

Install the attached cable gland in the cable entry, then pass the power cable through it

Connect the wires to the appropriate terminals as shown below

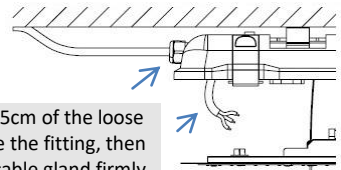
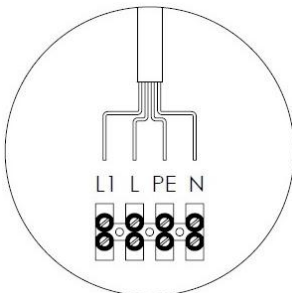

Leave 10-15cm of the loose cable inside the fitting, then screw the cable gland firmly

V. CLOSING THE FITTING

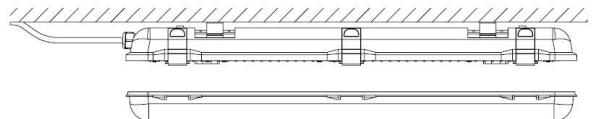

Re-install the mounting plate, secure it with its fixings, then put the diffuser / cover and secure it in place by means of closing clips

VI. AFTER INSTALLATION

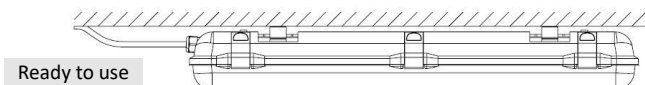

Ready to use